

Operation Manual

GT-2.0

GENESIS
TECHNOLOGIES™

AM/FM/CD/DVD/MP3/MP4
Digital 2.1 Surround Sound - Optical SPDIF Audio Input



Contents

Safety Guidelines

Important safety instructions	2
Safety compliance	2
Warnings	2
Warranty Information	3
At a glance	4
GT-2.0 Features	6
Radio Operation	10
DVD/CD/MP3/MP4 Operation	13
Bluetooth® Syncing	16
Placing a Call - GT-2.0	17
Placing a Call - Remote	18
Remote Control Guide	19
System Setup	23
Language	24
Audio	25
Video	26
Digital	27
Wiring Diagram	28
Troubleshooting	29
Accessories	30
GT-2.0 Specifications	31
FCC Compliance	31
Quick Start Guide	32



WARNING - To reduce the risk of electrical shock, do not remove cover (or open unit). **NO USER SERVICEABLE** parts are inside. Refer servicing to **QUALIFIED SERVICE PERSONNEL**.

The design and manufacture of this player takes personal safety into consideration. However, any improper operation may result in electric shock, fire, or other hazard.

DO NOT open the cabinet by yourself to prevent electric shock. Please contact a professional technician to preform any service needed. Please use only components recommended by factory when replacement is necessary.

Please turn unit off when not in use. Use a dry, soft cloth to clean face with the system turned off.

PRECAUTION - Moisture may cause the lens on loader in this unit to malfunction. To remedy the problem, turn unit on, eject disc and run 1-2 hours to vaporize moisture inside the unit. Do not repeatedly turn unit off and on. After turning unit off wait 10 seconds before turning on again. Do not use broken, scratched, or twisted discs in player. This could result in damage to the unit. Use only 5", 12cm discs in this unit.

ONE (1) YEAR LIMITED WARRANTY

The Manufacturer warrants to the original retail purchaser of this unit that is or any part therein, under normal use and condition, be proven defective in material or workmanship within 1 year from the date of original purchase, such defect's will be repaired or replaced at the manufactures option without charge for parts and repair labor.

This warranty does not extend to the elimination of externally generated static or noise, to the correction as antenna generated noise or to the cost incurred to correct this noise. The warranty does not cover the removal or the reinstallation of this unit or damage to any CD's, Speakers, accessories, or the vehicle's electrical system.

This warranty does not the cabinet appearance or apply to the unit or any part of the unit which, in the opinion of the manufacture, has been damaged through alterations, improper installation, mishandling, misuse, neglect, or accident, THE EXTENT OF THE MANUFACTURE'S LIABILITY UNDER THIS WARRANTY IS LIMITED TO THE REPAIR OR REPLACEMENT PROVIDED ABOVE , AND IN NO EVENT SHALL THE MANUFACTURE'S LIABILITY EXCEED THE PURCHASE PRICE PAID BY THE ORIGINAL BUYER FOR THE UNIT.

This warranty extends only to the original purchaser of the unit and is not transferable. Some states do not allow limitations on how long an implied warranty lasts, and some states do not allow the exclusion or limitation on incidental or consequential damages, so the above limitation of exclusions may not apply to you.

This warranty gives you specific legal rights. To obtain repair or replacement within the terms of this warranty, the radio is to be delivered with proof of purchase and a discription of the defect(s), freight prepaid to the original dealer or to:

QAV – Quest Audio Video
1930 W. Lusher Ave.
Elkhart, IN 46517
574-970-8349

GENESIS
TECHNOLOGIES™



GT-2.0

CD/MP3/MP4/DVD Disc Player

Compatible with standard size CD, MP3, MP4 and DVD discs (4.75" or 12cm). The GT-2.0 is designed to read standard DVD, MP3, MP4, CD, CD-R, CD-RW, JPEG-CD Disc. Because of variations in recording methods some discs may not play on this unit. This unit will play region 1 DVD's (USA and Canada).

USB / SD Card

This unit allows users to play files stored on both USB and SD cards including MP3 music, MP4 short video clips and JPEG photo files. The USB port will also charge many devices like iPods and MP3 players.

Built-In AM/FM Tuner

27 preset FM stations and 18 AM stations available to select.



The Bluetooth® word mark and logos are registered trademarks owned by Bluetooth SIG, Inc. and any use of such marks by Genesis Technologies is under license.

Bluetooth® Link

This unit contains Bluetooth® technology enabling secure, wireless connections between portable and fixed devices. This unit, when enabled can place and receive cellular phone calls through the GT-2.0s remote keypad and built in microphone.

The GT-2.0 Bluetooth® link also enables handheld control of streaming music from users wireless device play list.

This unit supplies quality high power audio and video outputs to three different rooms. Room A receives 2.1 digital surround sound. Room B and C receive standard stereo audio.

Sound Equalization Control

Allows control of the Bass, Treble, Balance and four preset EQ settings.

This unit has 1 Video Input, 3 Video outputs, 4 Audio inputs, 1 Digital Optical input and 1 Coaxial Input to allow users to enjoy entertainment from other sources such as Satellite Radio, Cable and Satellite TV, VCR's, Digital Cameras, Video Game players and a convenient 3.5mm Audio Input on the front panel

for iPods and MP3 Players. These sources must be connected through the inputs on the unit or through additional accessory wall plates. The Digital Optical input is used to enable digital audio from A/V components with digital optical output.

Clock

This unit has a built in clock that can display the time when any button is pressed and a sleep timer that turns off the radio for you.

GT-2.0 FEATURES



① **POWER**

Turns the power on and off.

② **IR**

Infrared remote sensor.

③ **MODE**

Select between AU1, AU2, AU3, AU4, AV1, BT, Radio

Note: Pressing and Holding the MODE button for 10 seconds will re-boot the radio and reset all defaults. It will leave the radio off. Press the on button to continue operation.

④ **AM/FM**

Allows you to select FM1, FM2, FM3, AM1, or AM2. Each band can be auto programmed with 9 station presets. 27 total preset stations for FM and 18 total preset stations for AM. (See FFWD or FRWD Radio Mode for auto scan features.)

⑤ **Bluetooth®**

Press this to enable Bluetooth® connectivity.

⑥ **VOLUME**

Increase or decrease the volume in all rooms where sound is being played.

⑦ **PLAY / PAUSE**

Press to play disc or pause playback of disc.

⑧ **EJECT**

Press to eject a Disc from your GT-2.0 built in player.

⑨ **FWD and RWD buttons**

Radio Mode: Press to select next frequency, higher or lower.

DVD Mode: Moves menu selection.

⑩ **F. RWD**

Radio Mode: Press to auto scan and memorize band preset stations. Scan through all lower preset stations.

Disc Mode: Select different levels of fast reverse.

⑪ **SPEAKERS A-B- C**

Turns sound on or off in corresponding rooms A, B or C.

⑫ **MIC**

Microphone for Bluetooth® cell phone communications.

⑬ **CLOCK**

Press this to see time. This function works in all modes and even when the unit is turned off. Press to change to the clock display. Press and hold to turn the display indication and button illumination off or on.

GT-2.0 FEATURES

14 AUDIO SETUP

Controls under this menu include Volume, Bass, Treble, Balance and EQ controls.

Volume:	39 different levels
Bass:	14 different levels
Treble:	14 different levels
Balance:	14 different levels
EQ:	Pop, Class, Rock, Flat

15 MUTE/HOLD

Press to turn off the sound. To turn on the sound, press again. While talking on the phone, press to put the call on hold. Works on all rooms where the sound is being played.

16 STOP

Press to stop playback of disc. Press Play to continue the playback

17 CD/MP3/MP4/DVD Disc loading slot

Insert a disc to play. *Compatible with standard size CD, MP3, MP4 and DVD discs (4.75" or 12cm). The GT-2.0 is designed to read standard CD, MP3, MP4, DVD, DVD+R, DVD-R Disc. Because of variations in recording methods some discs may not play on this unit. This unit will play region 1 DVD's (USA and Canada).*

18 PREVIOUS / NEXT Double Arrows

Radio Mode: Press these buttons for station seek.

Bluetooth® Mode: Press Previous to end a phone call. Press Next to start a phone call.

19 F. FWD

Radio Mode: Press to auto scan and memorize band preset stations. Scan through all higher preset stations.

Disc Mode: Select different levels of fast forward.

20 JTAG port

Used for firmware upgrades by authorized Genesis Technologies technicians only.

21 AU1 Port

Audio Input from MP3 or iPod player. This is a 3.5 MM input.

22 SD Card slot

Reads media stored on SD cards. The GT-2.0 supports SD cards with up to 8GB capacity. The SD card must be formatted to be FAT or FAT32.

23 USB port

The USB port will also charge many devices like iPods, MP3 players and cameras. Plus, allows users to play files stored

on USB and USB attached media devices, including music, video and photo files. The GT-2.0 supports USB flash drives with up to 8GB capacity. The USB drive must be formatted to be FAT or FAT32.

GT-2.0 DISPLAY SCREEN

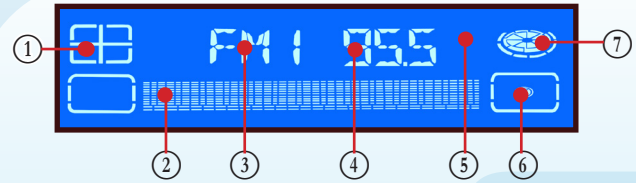

- ① STEREO
- ② VOLUME
- ③ BAND
- ④ FREQUENCY
- ⑤ PRESET
- ⑥ EQ SETTINGS
- ⑦ REMOVABLE MEDIA

RADIO OPERATION

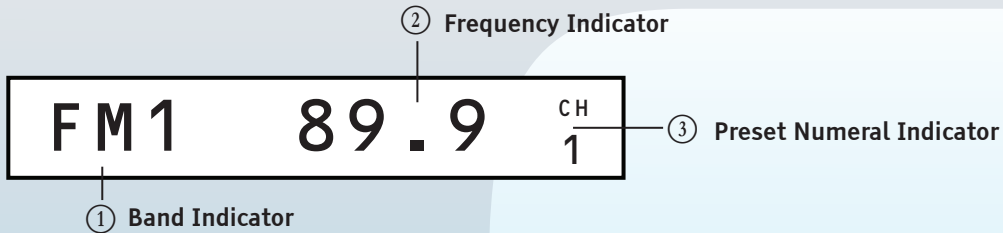

POWER

Turns the power on and off.



Press for power "On or Off"

Radio Reception Mode

Press to access the radio, press to activate desired band: AM1, AM2, FM1, FM2, FM3.

AM / FM

AM / FM

Activate radio

Press for
desired Band

Manual Tuning

Select Band, Select single arrowed button to move the chanel down or up.

AM / FM

RWD

FWD

Select Band

Chanel Down

Chanel Up

Auto Search Tuning

Push to auto search for an available station at a higher or lower frequency. When this function is selected the unit will stay at the selected station until another function is selected.

AM / FM

Select Band



PREVIOUS

Auto Search
Down



NEXT

Auto Search
Up

Manual Frequency Presets (Remote Control Only)

Select Band, Select desired frequency, Hold desired numeral for 3 seconds. Frequency is set. Repeat to change. Frequency can be preset for AM1, AM2, FM1, FM2, FM3.

AM / FM

Select Band
AM1, AM2, FM1,
FM2, FM3



RWD

Select
Frequency

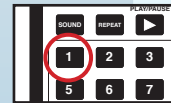

Select Numeral
and HOLD till
blinking

Recall Frequency Presets (Remote Control Only)

Select Band AM1, AM2, FM1, FM2, FM3, then select desired numeral

AM / FM

Select Band
AM1, AM2, FM1,
FM2, FM3



Select Numeral

RADIO OPERATION

Auto Best Station Memory

While in FM1 if you press the FAST FWD button the radio will start scanning from low to high frequencies.,or FAST RWD button the radio will start scanning from high to low frequencies. Each strong station found will be stored in a preset button until all 27 FM presets are full. You can also do this with the AM band. There are 18 presets available for the AM band.

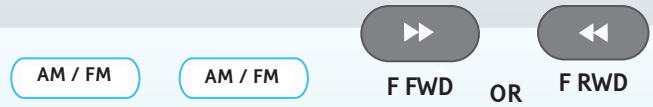

Activate radio	Press for desired Band FM1	Scan from low to high	Scan from high to low
----------------	----------------------------	-----------------------	-----------------------

Clock Setting the time

Press and hold the CLOCK button for 3 seconds. Hour will flash. Use the VOLUME UP/DOWN to set correct hour. Press SOUND button move to minutes. Minutes will flash. Use the VOLUME UP/DOWN to set correct minutes. Press the CLOCK button to memorize

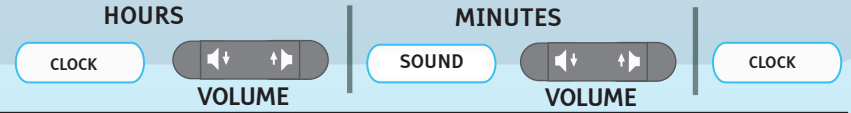

Press for 3 seconds Hours will flash	Use the VOLUME UP/DOWN to set correct hour	Press button for minutes.	Use the VOLUME UP/DOWN to set correct minute	Press to memorize
---	--	---------------------------	--	-------------------

SIRIUS/XM Satellite Radio

SEE Accessories Page 30.

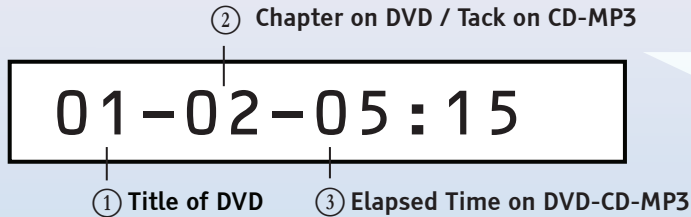

Load a Disc

There are several ways to select and load a disc in the GT-2.0. If you have left a disc in the unit you can just press PLAY. If you are using the remote, press the PLAY button. Either of these options will start the disc playing. Another way to play a disc is to insert it into the slot. The unit will switch to LOAD by it self.



Insert Disc into built-in GT-2 Player loader, label side facing up



LOAD will automatically appear in the display

Eject a Disc

Regardless of which function is playing, if the eject button on the front panel or the remote control is pushed, the unit will stop playing and eject the disc. The unit will keep the disc in the slot with EJECT showing on the Digital Display. If there is no disc inside the unit, a disc placed in the slot will be taken inside automatically with LOADING showing on the Digital Display.
NOTE: When the unit ejects and the disc isn't removed after 1 minute, the unit will automatically reload the disc. This feature protects the disc from being dropped and damaged.



Press EJECT



DVD/CD/MP3/MP4 OPERATION

PLAY / PAUSE

Normally, when the unit accepts a disc with no Playback Control, the unit will play the disc from the beginning. When a Playback Control exists, the user needs to push the PLAY button to start to play the disc. If the user pushes this button again, the unit will pause the disc. To release Pause, push this button again, and play will continue.



PLAY/PAUSE

Push to pause disc.



PLAY/PAUSE

When disc is paused, push to play disc.

Stop

When the unit is playing, push the STOP button to stop playing the disc.



STOP

Push the STOP button to stop playing the disc.

Fast Reverse / Fast Forward

Regardless whether you use fast forward or fast reverse, (during DVD mode) there are 6 different speeds to select from: 1X, 2X, 4X, 8X, 16X, 20X To select a normal speed, push the PLAY button. The unit will immediately play the disc at a normal speed. On the unit the PLAY button must be pressed second time to Play from Pause.



F RWD

Push the Fast Rewind button to rewind DVD



F FWD

Push the Fast Forward button to advance the DVD



PREVIOUS



NEXT

Previous / Next

Pushing the Previous button, the unit will play the disc from the beginning of the previous track. Pushing the Next button, the unit will play the disc from the beginning of the next track.

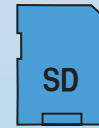

To Load USB and SD Media

Insert USB device or SD card into proper socket on the front of the radio to begin playing media. To view, navigate and select between music and video/photo media the TV or Monitor must be on and set to AV mode. Use remote NAVIGATION buttons to navigate on screen menu.

Because of variations in 3rd party recording methods some discs, USB devices or SD cards may not play on this unit. Also, the SD and USB ports are capable of playing short video clips. Long playing video files may experience buffering delays and video freeze if viewing is attempted through these ports. Bluetooth® is not video enabled and will not play video files.

Bluetooth® PAIRING

Pairing the GT-2.0 with a Bluetooth® device

With the GT-2.0 powered on Press the button marked “Bluetooth®” to enter Bluetooth® setup. The GT-2.0 screen will report “NO LINK” until a Bluetooth® device is successfully paired with the GT-2.0.

The GT-2.0 will send a password request to the Bluetooth® device that reads “Enter a numeric PassKey for GENESIS TECHNOLOGIES ****”. The factory default pass key is (0000). Enter the 4 digit numeric code to unlock the Bluetooth® connection. The GT-2.0 will send a confirmation request to the device that reads “Accept Connection Request from GENESIS TECHNOLOGIES?” Confirm GENESIS TECHNOLOGIES connection to successfully pair device with the GT-2.0

Pairing the GT-2.0 to a cell phone will configure the GT-2.0 to allow hands-free listening and talking. The built in microphone is located on the face of the GT-2.0 with a range of 12 feet. Sound is transmitted to any of the selected rooms A, B and or C.

The paired Bluetooth® connection also allows remotely controlled streaming stereo audio from the paired device from as far away as 25 feet.

Bluetooth® pairing is not video enabled.



Press the “Bluetooth®” button to enter setup



Enter a numeric PassKey

PLACING A CALL - GT-2.0

Placing a call with the GT-2.0 Using the Radio and Remote Control buttons

To place a call using the GT-2.0 with a paired Bluetooth® enabled cell phone first enable the GT-2.0 Bluetooth® mode by pressing the “MODE” button or by pressing the “Bluetooth®” button until “BT” and “LINK OK” appears on the GT-2.0 display. Using the GT-2.0 remote control’s keypad dial the desired phone number. Press the button marked “NEXT” to initiate the call. To end the call press the button marked “PREVIOUS”. To redial the last call press the button marked “NEXT”.

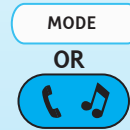

Press the “MODE” button or press the “Bluetooth®” button



Use remote control keypad dial the desired phone number



Press the button marked “NEXT” to initiate the call.



To end the call press the button marked “PREVIOUS”.

Receiving a call with the GT-2.0 Using the Radio Buttons

To receive an incoming call while the GT-2.0 is paired with Bluetooth® enabled cell phone press the button marked “NEXT”. To end the call press the button marked “PREVIOUS”.



Press the button marked “NEXT” to receive an incoming call.



To end the call press the button marked “PREVIOUS”.

PLACING A CALL - REMOTE

Placing a call with the GT-2.0 Using the Remote buttons

To place a call using the GT-2.0 with a paired Bluetooth® enabled cell phone press the remote button marked “INPUT” until “BT” and “LINK OK” appear on the GT-2.0 display.



INPUT

Using the remote numeric keys dial the desired phone number then press the remote button marked “NEXT” to initiate the call. To end the call press the remote button marked “PREVIOUS”.



NEXT



PREVIOUS

Receiving a call with the GT-2.0 Using Remote Buttons

To receive an incoming call while the GT-2.0 is paired with Bluetooth® enabled cell phone press the remote button marked “NEXT”.

To end the call press the remote button marked “PREVIOUS”.



NEXT



PREVIOUS

Special dialing REMOTE keypad functions

To clear an entry press the button marked SETUP

To type star (*) press the button marked FF

To type pound (#) press the button marked FR



SETUP



FF



FR

REMOTE CONTROL Guide

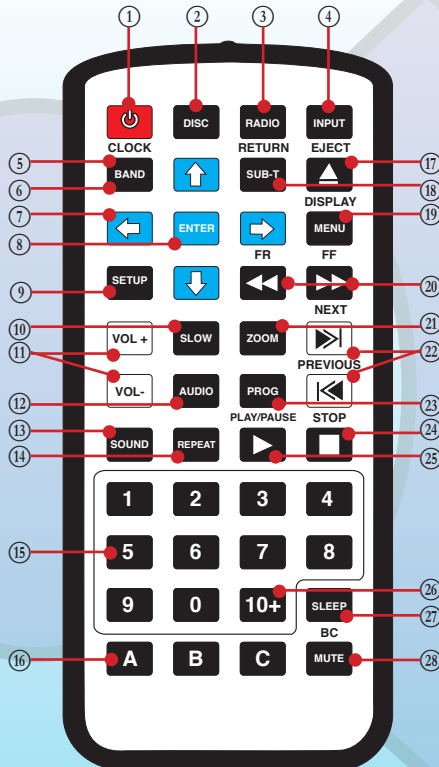

- ① **Power**
Turns the power on and off.
- ② **Disc**
Press to select Disc mode when a disc is already in the unit.
Press Disc to select USB or SD.

To view, navigate and select between music and video/photo media the TV or Monitor must be on and set to AV mode.
Use NAVIGATION buttons to navigate on screen menu.
- ③ **Radio**
This function selects the Radio.
- ④ **INPUT**
Press to select AU1, AU2, AU3, AU4, AV1 and BT.
- ⑤ **CLOCK**
TO change clock settings press and hold CLOCK/Band key for 3 seconds. Press Volume up or down to adjust Hours.
Press the Audio key then Volume up or down to adjust Minutes.

Refer to page 12 for clock setting adjustments.

REMOTE CONTROL Guide

⑥ BAND

Once the radio is selected, this button allows you to select FM1, FM2, FM3, AM1, AM2. Push the "RADIO" button and the unit switches to Radio immediately. During radio mode, press "RADIO" again to switch receiving band.

⑦ NAVIGATION BUTTONS

Press the appropriate button to move around any menus that are selected on screen. Center button is the "select / enter" button.

⑧ ENTER

Use to finalize selection.

⑨ SETUP

Press the "SETUP" button to activate the System Setup on screen display Video Monitor menu . Use the NAVIGATION buttons to navigate the OSD menu options.

⑩ SLOW

Pressing the SLOW button while in DVD mode turns on slow motion play back in steps of 1/2, 1/3, 1/4, 1/5 and 1/6 of standard play speed.

⑪ VOLUME

Press the "VOLUME" (+ or -) button to increase or

decrease the volume level respectively.

⑫ AUDIO - DVD Only

Adjusts the surround sound mode as well as selects the language. Must be set before play.

⑬ SOUND

Radio Mode: Repeatedly pressing the "SOUND" button moves you through 6 modes. VOLUME, BASS, TREBLE, BALANCE, EQ and TIME. Adjustment in anyone of these modes is done by pressing the "VOLUME" (+ or -) key. Controls can be modified differently for each room.

⑭ REPEAT

DVD Mode: Press "REPEAT" to repeat the current track being played. Press it twice to repeat playing all of the tracks.

CD, MP3, VCD Mode: Press "REPEAT" to repeat the current track being played. Press it twice to cancel the repeat function.

⑮ 0-9 NUMBERS

Radio Mode: You can select one of the 9 stored stations on each band by pressing any one of the number buttons (1-9).

REMOTE CONTROL Guide

Disc Mode: You can select any track directly by using the number buttons (0-10+). *Example: If you want track number 25. Consecutively press the number 2, then 5 and track number 25 will begin to play.*

16 A, B and C Rooms

Turns sound on or off in the corresponding rooms A, B or C.

17 EJECT

When the unit is in Disc Play mode, pushing the “EJECT” button will eject the disc. When the unit ejects a disc and the disc is not removed after 1 minute, the unit will automatically reload the disc.

18 SUBTITLE (SUB-T) / RETURN

DVD only. Returns to previously selected tracks. Press to select language or to turn off subtitles. Press and hold for 3 seconds to return to previous chapter.

19 MENU / DISPLAY

DISC only. Selects upper menu. Press the button for 3 seconds to display the status of the DVD or CD that is currently playing.

CD/VCD/DVD Mode: Press the “DISPLAY” button and the

GT-2.0 Display Screen and attached Video Monitor will show single track elapsed time, single track remaining time or entire disc time, It also shows the track being played and the amount of the whole disc.

MP3 Mode: Press the “DISPLAY” button and the OSD will show single track elapsed time only.

20 FAST REVERSE / FORWARD

Press to select different levels of Fast Reverse or Fast Forward. Press Play to resume selection.

21 ZOOM - DVD Only

DVD, VCD: Press the “ZOOM” button once to enable 2X zoom mode. Pressing the “ZOOM” button repeatedly moves the zoom mode through 3X, 4X, 1/2X, 1/3X, and 1/4X zoom levels. Press “ZOOM” again to exit the zoom mode.

22 PREVIOUS / NEXT

Radio Mode: Press to select higher or lower stations.

Disc Mode: Press to select previous or Next track or chapter. Pushing the Previous button, the unit will play the disc from the beginning of the previous track. Pushing the Next button, the unit will play the disc from the beginning of the next track.

REMOTE CONTROL Guide

②③ PROGRAM

CD/VCD: You can set the program order to play, by following the steps below. Press “PROGRAM” button and the LCD displays programming P00:00. You can set the program order to play them by using (0-10+) number button, and then press “PLAY/PAUSE” to play.

Note:

- (1) Program does not function in playing MP3.
- (2) CD Only- Allows you to re-arrange the play back order of the individual tracks differently from the order on the original disc.
- (3) If there are mistakes in programs, you can press “PROGRAM” button again then press “PROGRAM” button to play in order.

②④ STOP

DVD, VCD, CD: Press “STOP” to suspend playback mode. STOP will display on the TV Screen. Pressing “STOP” a second time will end all disc playback.

②⑤ PLAY / PAUSE

Press “PLAY/PAUSE” button to suspend the playback of CD, MP3, MP4, VCD and DVD media. Press it again to return to normal playback mode.

②⑥ 10+

Radio: N/A

Disc: Press the 10+ button to select tracks numbered higher than 100 on MP3s.

②⑦ SLEEP

Selects timing for delayed turn-off mode. Available increments 90, 80, 70, 60, 50, 40, 30, 20 and 10 Minutes.

②⑧ MUTE / BC

Press the “MUTE” button to turn off the sound in all rooms A, B, and C. Press it again to resume the previous sound levels. Pressing the BC button for 5 seconds returns the system to default settings.

SYSTEM SETUP

Press the “SETUP” button to activate the System Setup on screen display Video Monitor Only menu .

Use the NAVIGATION buttons to navigate the following OSD menu options.

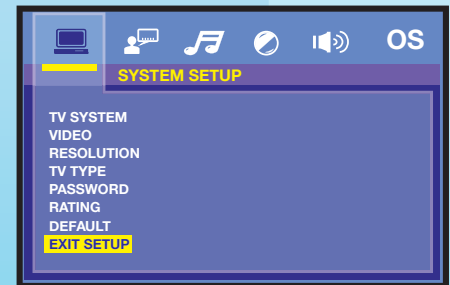
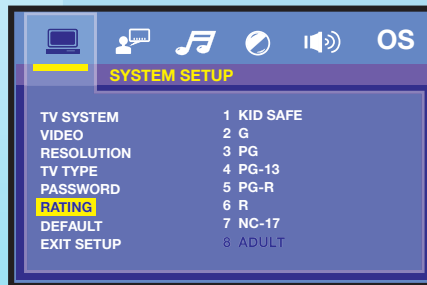
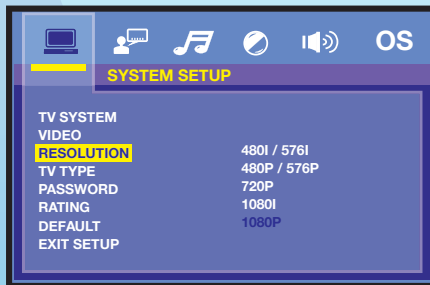
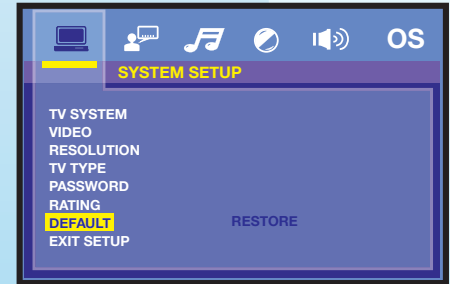
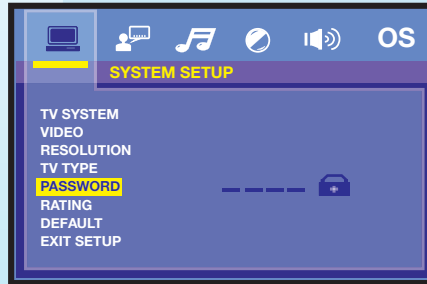
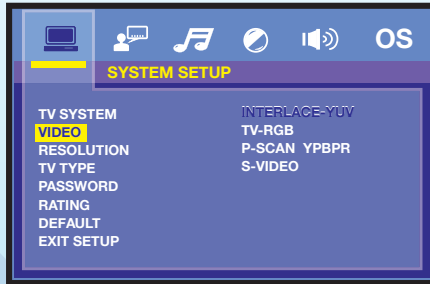
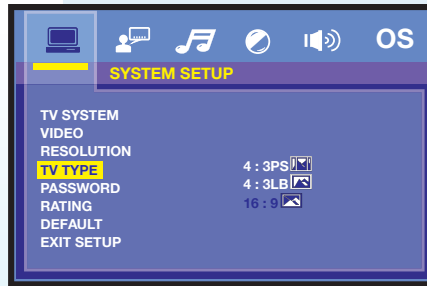
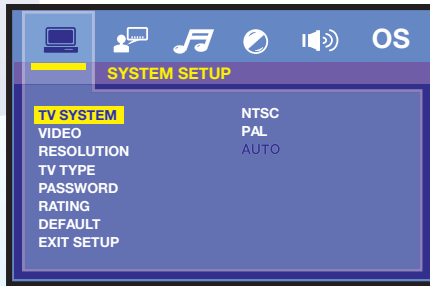

LANGUAGE SETUP

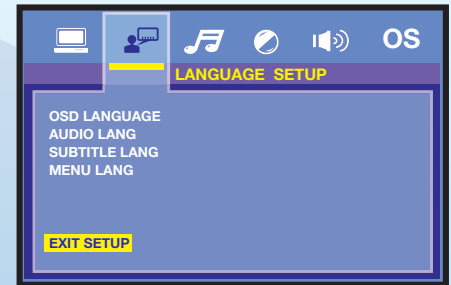

AUDIO SETUP

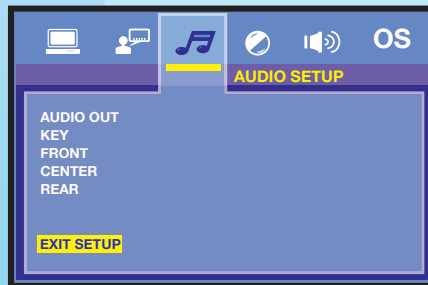
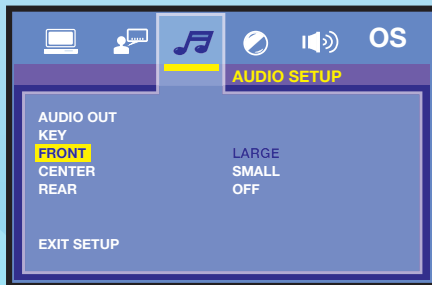
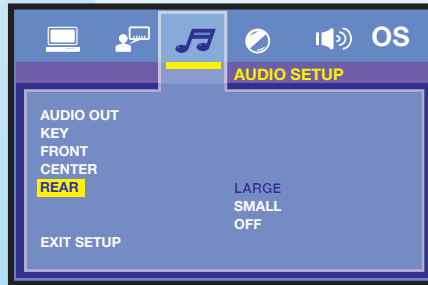
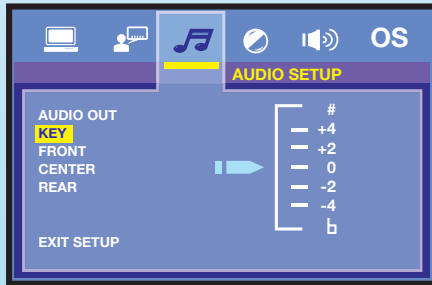
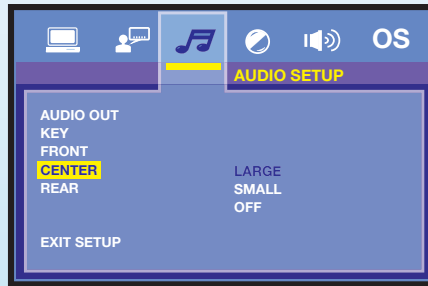
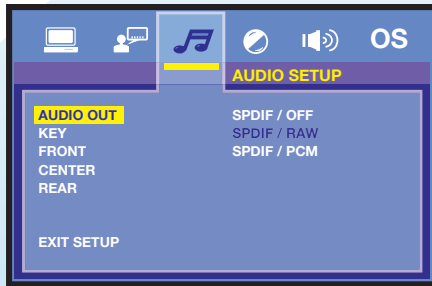

VIDEO SETUP

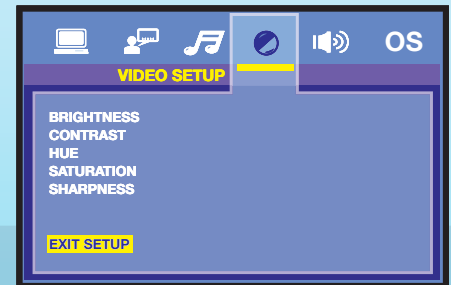
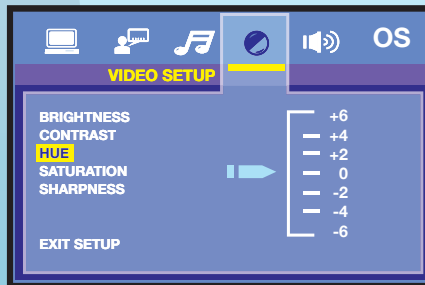
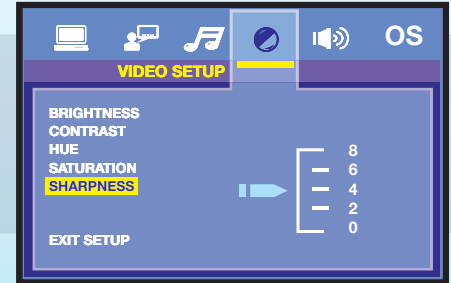
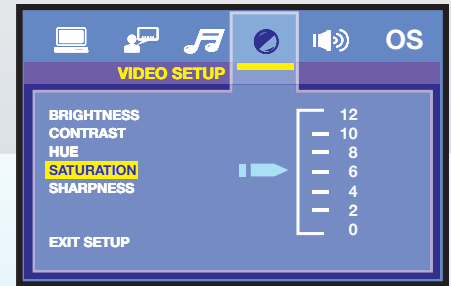
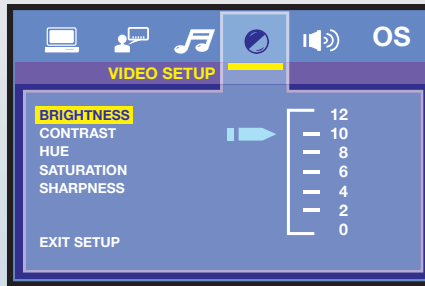

OUTPUT SETUP

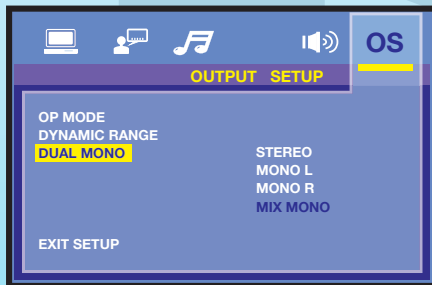
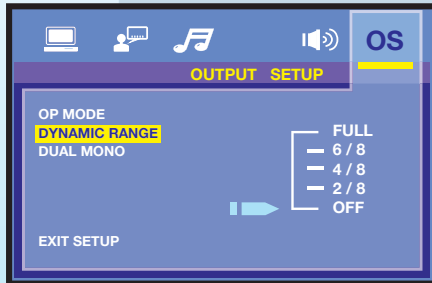
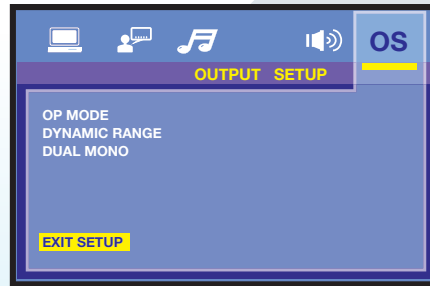
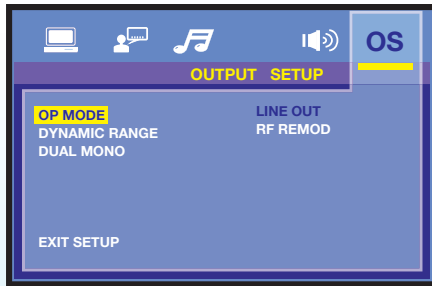

WIRING DIAGRAM

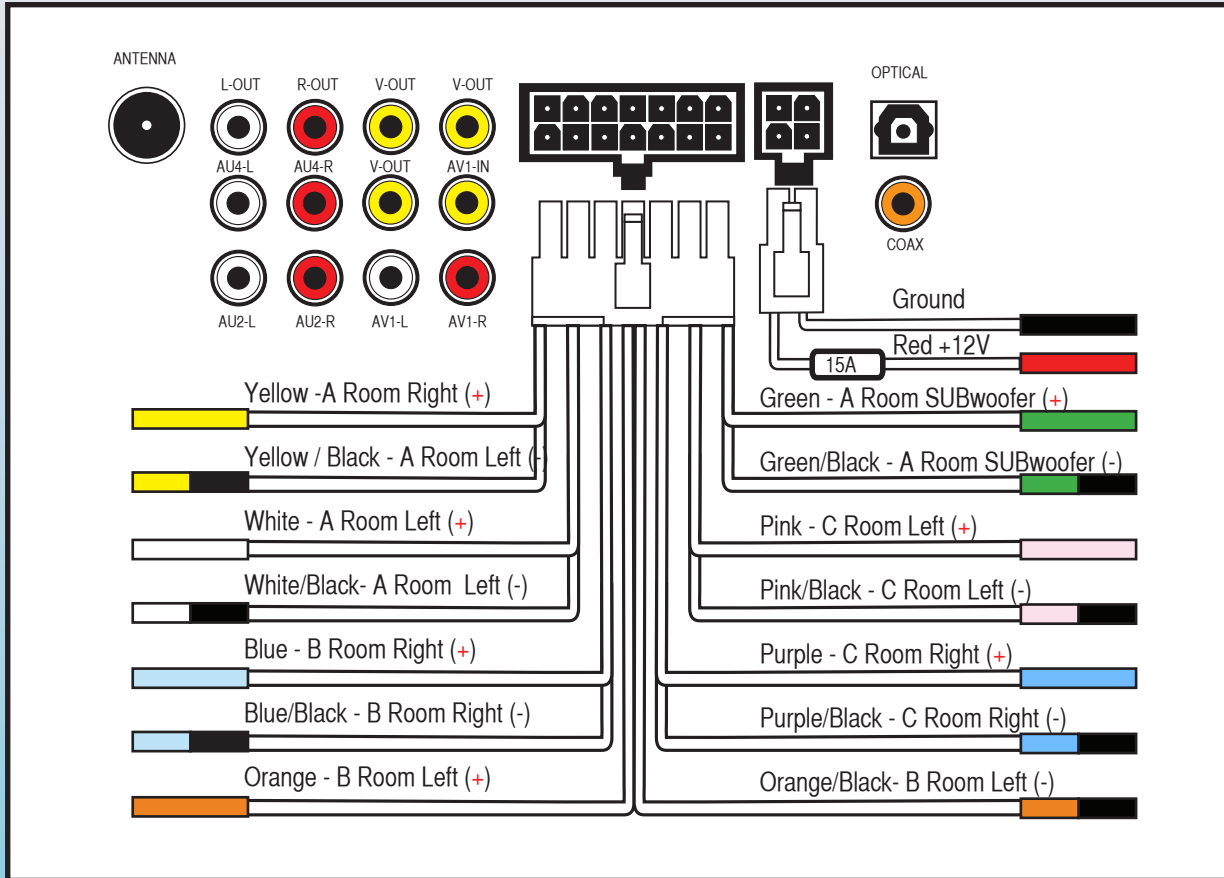

No Power

- Check and make sure whether the fuse is blown, replace fuse with proper value if necessary.

Some errors occur in the LCD or no function when pressing the button.

- Turn off the unit and restart the unit again. Use Factory Default Restart.

Poor radio reception or static.

- Antenna may not be the proper length. Make sure the antenna is fully extended. Antenna may be broken. Replace antenna.
- The broadcast signal is too weak.
- The antenna is poorly grounded. Check and make sure the antenna is properly grounded at it's mounting location.

Disc cannot be loaded

- Disc is loaded in the machine. Clear the disc by pressing eject

No Picture.

- The Video line from the main unit to the TV is not connected properly. Check connections.
- Improper setting of the TV SYSTEM. Set the TV SYSTEM to "PAL" or "NTSC", according to the connected television.

Disc error appears.

- The disc may be damaged or dirty. Clean disc and retry.

When there is no color on video.

- Turn off the unit and restart the unit again. Use Factory Default Restart.

FACTORY DEFAULT RESTART

Press and hold MODE button for 10 seconds - Unit will shut off. Restart unit by pressing the ON button. Factory defaults will be reset with this type of restart.

NOTE:

If any of the problems persist after check list has been made, consult your nearest service dealer. Never attempt to disassemble your unit by yourself.

ACCESSORIES

onyX Wall Plate

onyX receiver installation

1. Press the top of the spring loaded *onyX* wall plate cradel to release the cradel from the wall plate.
2. Insert the *onyX* receiver into the cradel.
3. Press and push the top of the *onyX* receiver into the wall plate to finish the installation.

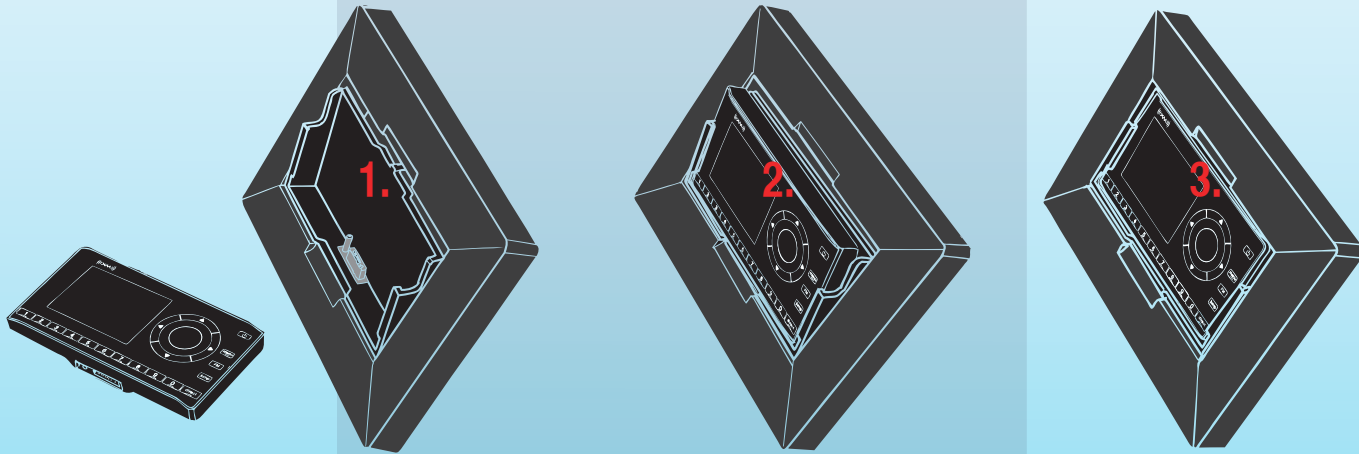

GT-2.0 SPECIFICATIONS

Overall Dimensions	9-5/8" (W) x 8-1/2" (H) x 6" (D)
Mounting Dimensions	7-3/4" (W) x 7-1/2" (H) x 5" (D)
Net Weight	5lbs (2.3Kg)
Voltage	12V DC Negative Ground (11.0V - 15.0V allowable)
Maximum Current Consumption	9A
Total Continuous Power Output	50W
Load Impedance	4Ω (4-8Ω allowable)
Total harmonic distortion	Typical 0.02% Maximum 0.3%
DVD Deck Section, Discs Played	DVD, MP3, MP4, CD, CD-R, CD-RW, JPEG-CD
Video System	AUTO / PAL / NTSC
Video Section	4:3 Letter Box and 4:3 Pan Scan, 16:9
Video Output level	1.0Vp-p +/-0.2V 75ohms
AM Tuner Section, Frequency Range	530 - 1710KHz (U.S.A.)
FM Tuner Section, Frequency Range	87.5-107.9MHz (U.S.A.)
Bluetooth®	Version 2.0, Class II
Advanced Audio Distribution	OPP, OBEX, SPP, A2DP, AVRCP

FCC COMPLIANCE

15.19 Labeling requirements.

(a) In addition to the requirements in part 2 of this chapter, a device subject to certification, or verification shall be labeled as follows.

(1) Receivers associated with the operation of a licensed radio service, e.g., FM broadcast under part 73 of this chapter, land mobile operation under part 90, etc., shall bear the following statement in a conspicuous location on the device: This device complies with art 15 of the FCC Rules. Operation is subject to the condition that this device does not cause harmful interference.

(2) A stand-alone cable input selector switch, shall bear the following statement in a conspicuous location on the device: This device is verified to comply with part 15 of the FCC Rules for use with cable television service.

(3) All other devices shall bear the following statement in a conspicuous location on the device:

This device complies with part 15 of the FCC Rules. Operation is subject to the following two conditions:

(1) This device may not cause harmful interference, and (2) this device must accept any interference received, including interference that may cause undesired operation.

GT-2.0 QUICK START GUIDE

AM/FM/CD/DVD/MP3/MP4 Digital 2.1 Surround Sound - Optical SPDIF Audio Input

- ① **POWER**
Turns the power on and off.
- ② **IR**
Infrared remote sensor.
- ③ **MODE**
Select: AU1, AU2, AU3, AU4, AV1, BT, Radio
- ④ **AM/FM** Allows you to select FM1, FM2, FM3, AM1, or AM2.
- ⑤ **Bluetooth®**
Press this to enable Bluetooth® connectivity.
- ⑥ **VOLUME**
Increase or decrease the volume in all rooms.
- ⑦ **PLAY / PAUSE**
Press to play disc or pause playback of disc.
- ⑧ **EJECT**
Press to eject a Disc from your GT-2.0 built in player.
- ⑨ **FWD and RWD buttons**
Radio Mode: Press to select next frequency, higher or lower.
DVD Mode: Moves menu selection.
- ⑩ **F. RWD**
Radio Mode: Auto scan and memorize band preset stations.
Disc Mode: Select different levels of fast reverse.

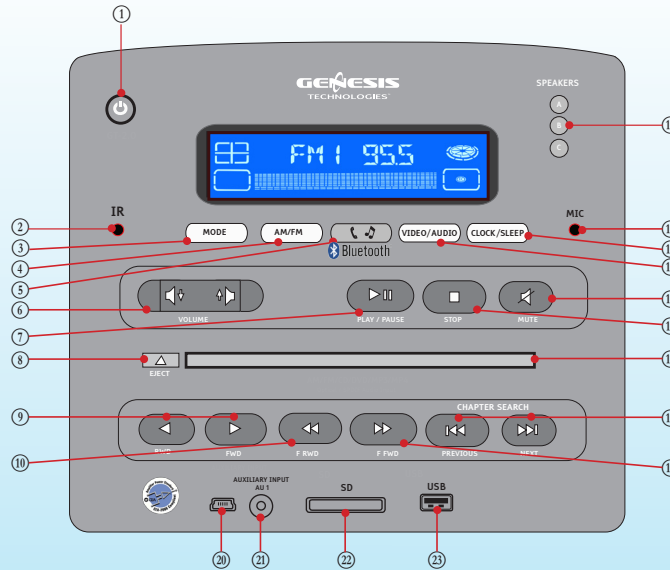

- ⑪ **SPEAKERS A-B- C**
Turns sound on or off in rooms A, B or C.
- ⑫ **MIC**
Microphone for Bluetooth® cell phone communications.
- ⑬ **CLOCK**
Displays users set time.
- ⑭ **AUDIO SETUP**
Selects audio setup menu.
- ⑮ **MUTE/HOLD**
Press to turn off and on the sound.
- ⑯ **STOP**
Press to stop playback of disc.
- ⑰ **CD/MP3/MP4/DVD Disc loading slot**
- ⑱ **PREVIOUS / NEXT**
Selects previous and next chapter in DVD
- ⑲ **F. FWD**
Selects next frequency higher.
- ⑳ **JTAG port**
Used for firmware upgrades
- ㉑ **AU1 Port**
Audio Input from MP3 or iPod player.
- ㉒ **SD Card slot**
Reads media stored on SD cards.
- ㉓ **USB port**
Charges and reads USB devices.

Radio - Remote

1. Press the lighted red "POWER" button on the front panel to turn on the unit.
2. Select speakers "A" for living room, "B" for bedroom and "C" for outdoor speakers.

3. To listen to radio press "AM/FM" to select bands AM1, AM2, FM1, FM2 or FM3.

4. **RADIO:** To tune up or down to the next station press "FWD" or "RWD"

4. **REMOTE:** To tune up or down to the next station press "NEXT" or "PREVIOUS"

5. To auto program any available stations into the (27 FM) and (18 AM) memory station presets enter FM band and press "FFWD" and the GT-2.0 will automatically scan available radio stations and load them into station preset memory. Repeat this auto scan function for both AM and FM bands. Use the remote con-

trol numeric keypad 1-9 to recall the memorized station presets.

6. To manually preset a station tune radio to the desired station, press and hold a number 1-9 on remote keypad to commit the station to memory. To recall that station press the remote preset number you selected.

GT-2.0 QUICK START GUIDE

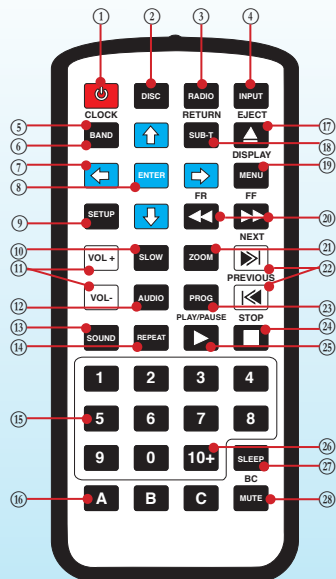

- ① **Power**
Turns the power on and off.
- ② **Disc**
Press to select Disc mode when a disc is already in the unit. Press Disc to select USB or SD.
- ③ **Radio**
This function selects the Radio.
- ④ **INPUT**
Press to select AU1, AU2, AU3, AU4, AV1 and BT.
- ⑤ **CLOCK**
Use to change clock settings.
- ⑥ **BAND**
Select FM1, FM2, FM3, AM1, AM2.
- ⑦ **NAVIGATION BUTTONS**
Press the appropriate button to move around menus.
- ⑧ **ENTER**
Use to finalize selection.
- ⑨ **SETUP**
Use to activate the System Setup on screen display Video Monitor menu .
- ⑩ **SLOW**
Pressing SLOW enables slow motion playback in steps of 1/2, 1/3, 1/4, 1/5 and 1/6 of standard play speed.
- ⑪ **VOLUME**
Increase or decrease the volume.
- ⑫ **AUDIO - DVD Only**
Selects audio setup menu.
- ⑬ **SOUND**
Radio Mode: 6 modes. VOLUME, BASS, TREBLE, BALANCE, EQ and TIME.
- ⑭ **REPEAT**
DVD Mode: Repeat current track or all tracks.
CD, MP3, VCD Mode: Repeat current track or cancel function.
- ⑮ **0-9 NUMBERS**
Radio Mode: One of the 9 stored stations on each band by pressing any one of the number buttons (1-9).
Disc Mode: You can select any track directly by using the number buttons (0-10+).
- ⑯ **A, B and C Rooms**
Turns sound on or off in the corresponding rooms A, B or C.
- ⑰ **EJECT**
Press to eject a Disc from your GT-2.0 built in player.
- ⑱ **SUBTITLE (SUB-T) / RETURN**
DVD only. Returns to previously selected tracks. Press to select language or to turn off subtitles.
- ⑲ **MENU / DISPLAY**
DISC only. Press to display the status of the DVD or CD that is currently playing.
MP3 Mode: Press the "DISPLAY" button and the OSD will show single track elapsed time only.
- ⑳ **FAST REVERSE / FORWARD**
Press to select different levels of Fast Reverse or Fast Forward. Press Play to resume selection.
- ㉑ **ZOOM - DVD Only**
Press to zoom 3X, 4X, 1/2X, 1/3X, and 1/4X.
- ㉒ **PREVIOUS / NEXT**
Radio Mode: Press to select higher or lower stations.
Disc Mode: Press to select previous or Next track or chapter.
- ㉓ **PROGRAM**
CD/VCD: You can set the program order to play.
- ㉔ **STOP**
Press to stop playback of disc.
- ㉕ **PLAY / PAUSE**
Press to play disc or pause playback of disc.
- ㉖ **10+**
Press the 10+ button to select tracks numbered higher than 100 on MP3s.
- ㉗ **SLEEP**
Delayed turn-off in increments of 90, 80, 70, 60, 50, 40, 30, 20 and 10 Minutes.
- ㉘ **MUTE / BC**
Press to turn off and on the sound.

Bluetooth®

1. Press lighted red "POWER" button on the front panel to turn on the GT-2.0.
2. Press the "Bluetooth®" button.
3. On handheld go to setup and "Add Device" then "Search for Device".

4. Select "GENESIS TECHNOLOGIES" and enter numeric passkey.

5. Default numeric passkey for GENESIS TECHNOLOGIES is 0000

6. Select "Yes" on handheld to pair device to GT-2.0.

CD MP3 DVD

1. To load a disc (CD, MP3 or DVD) insert disc into slot. Unit will read the disc and begin play.
2. Press "Next" or "PREVIOUS" to select tracks on CD's, MP3's and Chapters on DVD's.

3. Press "EJECT" to remove disc.

NOTES



GT-2.0

Operation Manual

GT-2.0

GENESIS
TECHNOLOGIES™

AM/FM/CD/DVD/MP3/MP4
Digital 2.1 Surround Sound - Optical SPDIF Audio Input

