



Intercoastal Ceiling Fans



Housing Colors:
Oil Rubbed Bronze
Brushed Nickel

Add an updated look to your home décor with our line of Intercoastal ceiling fans. These fans come in a variety of sizes and your choice of light kits. This 3-speed fan features four blades that come in your choice of black, white, oak, maple, and cherry.

If you have any questions about our Intercoastal ceiling fans, feel free to [contact](#) our office at (574)-971-4492

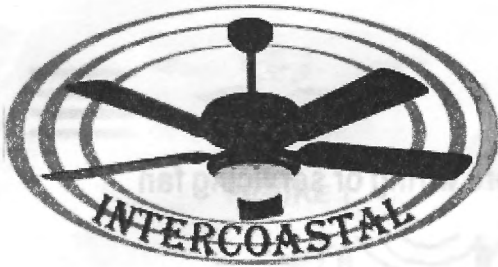

HUGGER

CFL-42ORB/CFL-42BN

CFNL-42ORB/CFNL-42BN

CFLM-425ORB/CFLM-425BM

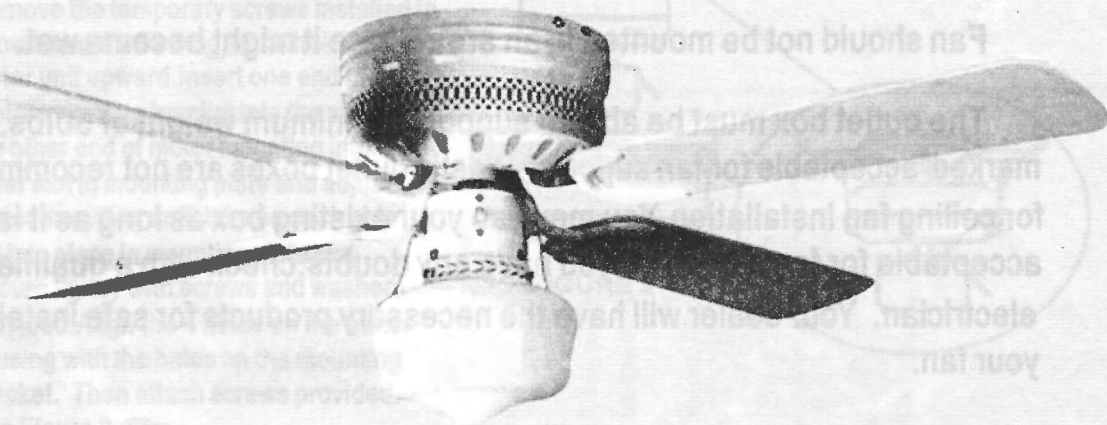

Owners Manual and Installation Instructions

Commitment to Excellence



Make sure to turn off electricity at main switch before wiring or servicing fan in order to avoid possible electrical shock.

All electrical wiring must conform to national and local Electrical Codes.

Make sure the fan is electrically grounded to avoid possible electrical shock.

Fan should be mounted a minimum of 7 feet above the floor to the fan blade. It should be a minimum of 20 inches from any wall to the blade tip.

Fan should not be mounted in an area where it might become wet.

The outlet box must be able to support a minimum weight of 50lbs. and marked "acceptable for fan support". Plastic outlet boxes are not recommended for ceiling fan installation. You may use your existing box as long as it is acceptable for fan support. If you have any doubts, check with a qualified electrician. Your dealer will have the necessary products for safe installation of your fan.

Never attach the blades to your ceiling fan before the fan is mounted to the ceiling. Do not operate your ceiling fan before the blades are installed.

For safety and best operating results, we recommend that you have a qualified electrician assemble and install your fan.

WARNING! TO REDUCE THE RISK OF PERSONAL INJURY, DO NOT BEND THE BLADE CARRIERS WHEN INSTALLING THE BRACKETS, BALANCING THE BLADES, OR CLEANING THE FAN. DO NOT INSERT FOREIGN OBJECTS IN BETWEEN ROTATING FAN BLADES.

WARNING! TO REDUCE THE RISK OF FIRE, ELECTRICAL SHOCK, OR PERSONAL INJURY, MOUNT THE FAN TO AN OUTLET BOX MARKED "ACCEPTABLE FOR FAN SUPPORT".



FIGURE 1

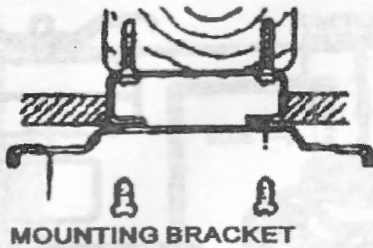

STEP 1

Secure the bracket to the ceiling outlet box using screws provided with the outlet box attach securely. There should be no movement between the bracket and outlet box. See Figure 1.

STEP 2

Remove the temporary screws installed to allow hand-free wiring, while holding motor unit upward. Insert one end of the motor mounting bracket into the slot and the other end of motor mounting into the other slot in mounting plate and adjust motor mounting until tabs on each side fall into place in mounting plate slot. Secure tightly with screws and washers provided. Align the 4 holes on the motor housing with the holes on the mounting bracket. Then attach screws provided. See Figure 2

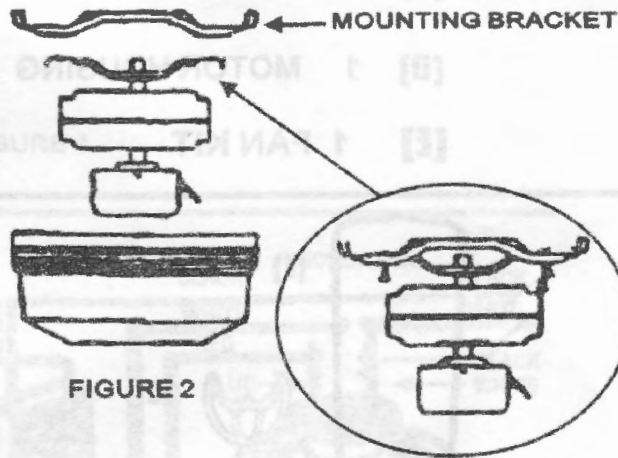

II. MAKING ELECTRICAL CONNECTIONS

FIGURE 3



WARNING: DISCONNECT POWER!!!

1. Attach the green wire from the fan to the ground wire in the junction box.
2. Attach the black wire and blue wire from the fan to the black wire in the junction box.
3. Attach the white wire from the fan to the white wire in the junction box.
4. Each of the above connections should be made as light as possible using a proper size plastic wire nut. Then fold the connected wire and push inside the junction box.

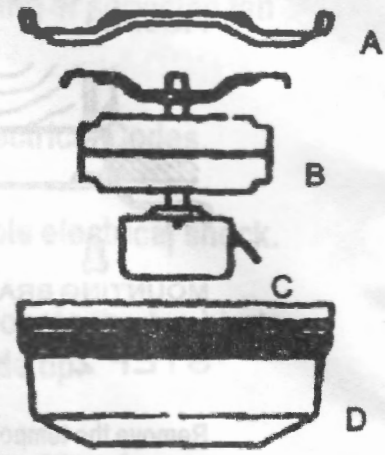

- [A]** 1 HANGING BRACKETS
- [B]** 1 FAN MOTOR
- [C]** 1 SWITCH HOUSING ASSEMBLY
- [D]** 1 MOTOR HOUSING
- [E]** 1 FAN KIT

FIGURE 1

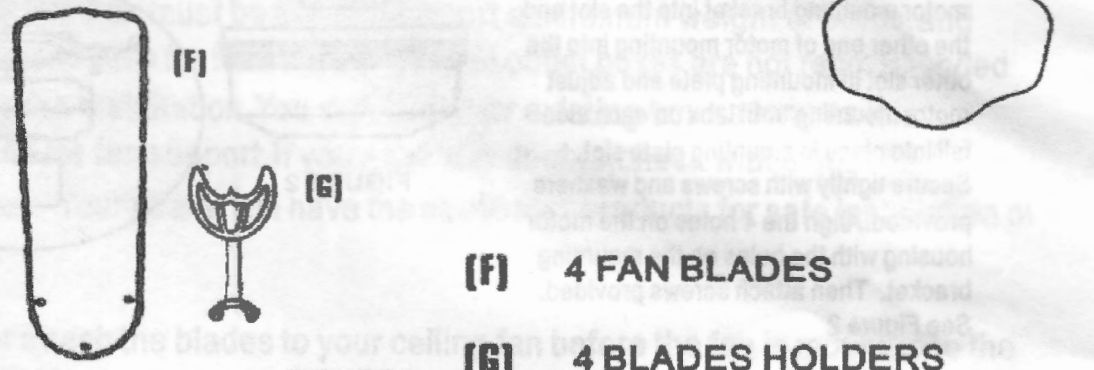

- [F]** 4 FAN BLADES
- [G]** 4 BLADES HOLDERS

FIGURE 2

- [H]** 1 HARDWARE BAG

- CONTAINS:
- a 2 WOOD SCREWS
 - b 2 HOUSING SCREWS
 - c 13 BLADE SCREWS
 - d 13 FIBER WASHERS
 - e 3 WIRE NUTS
 - f 2 FAN PULL TASSEL
 - g 9 BLADE HOLDER SCREWS

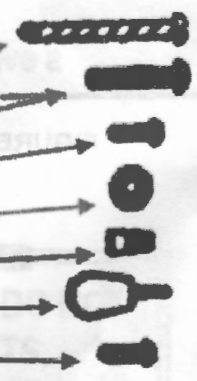

- [I]** 1 BALANCING KIT (1 BAG)

OPTIONAL WIRING DIAGRAMS

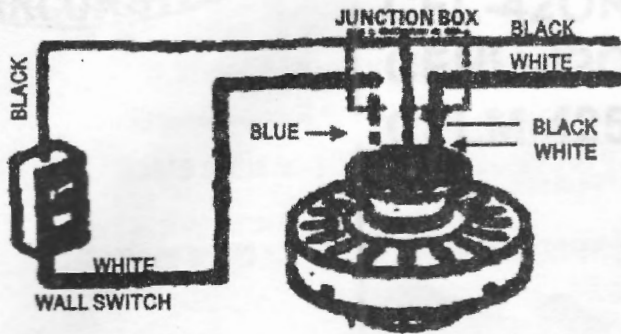

SWITCH TO CONTROL LIGHT

FIGURE 4

**LIGHT & FAN
(2 WALL SWITCHES)**

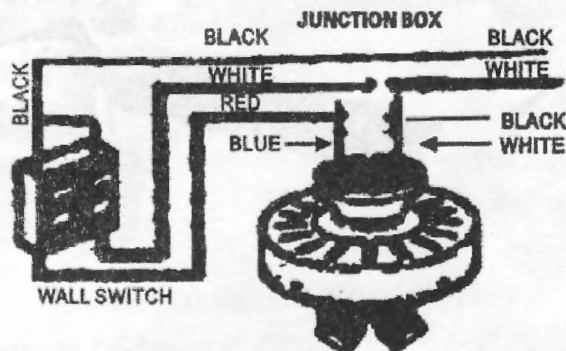

FAN BLADE TO BLADE HOLDER ASSEMBLY

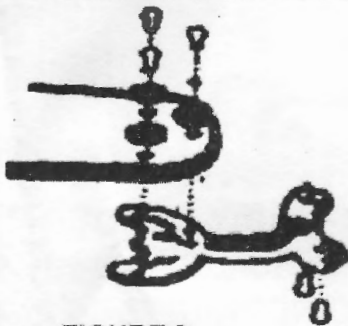

FIGURE 6

Attach the fan blade to blade holder using screws and washers supplied. Tighten each screw starting with the center screw making sure the blade is straight. Fasten the blade and assembly to the motor using the screws supplied. See figure 6

NOTE: THE BLADE HOLDERS AND BLADES HAVE BEEN CAREFULLY BALANCED TO AVOID WOBBLING WHEN THE FAN IS OPERATING. BE CAREFUL NOT TO BEND OR DAMAGE THEM.